

Yuasa Scheda Tecnica

Yuasa DCB125-6(ET) Pro-Spec Deep Cycle Battery

Specifiche tecniche

Tensione Nominale (V)	6
5-hr rate Capacity to 10.5V at 20°C (Ah)	195
20-hr rate Capacity to 10.5V at 20°C (Ah)	240
Capacità @ 75A (min)	132
Capacità @ 25A (min)	488

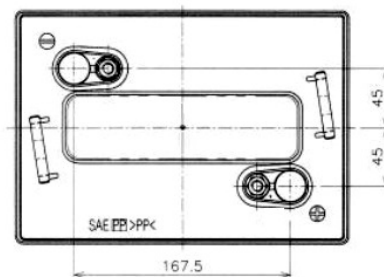

Capacità alla scarica in 5 ore con temperatura variabile

40°C	105%
30°C	100%
0°C	80%

Dimensioni

Lunghezza (mm)	259
Profondità (mm)	179
Altezza (mm)	245
Altezza poli inclusi (mm)	276
Peso (kg)	30.7

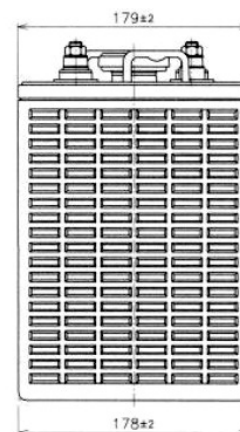
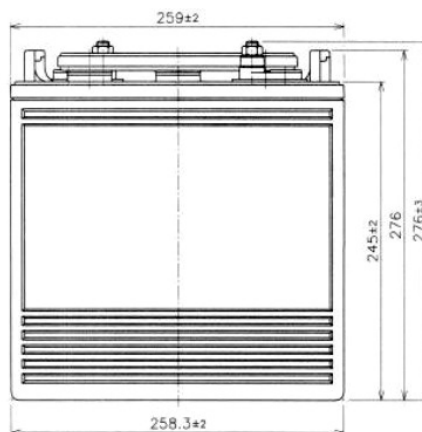

Specifiche dei materiali

Tipo di coperchio	: Rimovibile- Manutenzione Possibile
Tipo di valvola di sfiato	: Gang style
Materiale del monoblocco & coperchio	: Polipropilene nero
Metodo di sigillatura del coperchio	: Sigillatura a caldo
Connessione intercella	: Saldatura divisoria passante
Sistema di saldatura piastre	: Fusione automatica
Materiale piastra positiva	: Lega in alluminio-antimonio
Materiale piastra negativa	: Lega in alluminio-antimonio

POSITIVE TERMINAL S=1:1

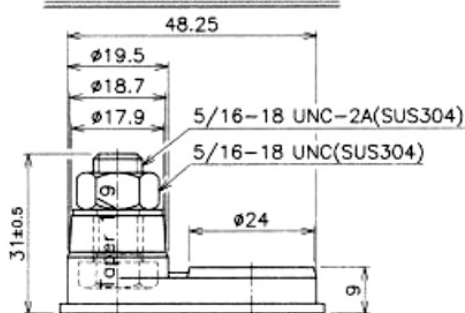

NEGATIVE TERMINAL S=1:1

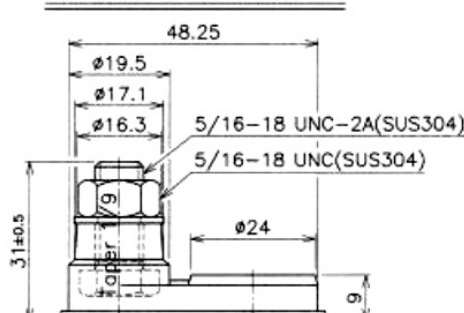

Scheda tecnica prodotta su E&OE

Yuasa Technical Data Sheet

Yuasa DCB125-6(ET) Pro-Spec Deep Cycle Battery

Specifications

Nominal voltage (V)	6
5-hr rate Capacity to 10.5V at 20°C (Ah)	195
20-hr rate Capacity to 10.5V at 20°C (Ah)	240
Capacity @ 75A (mins)	132
Capacity @ 25A (mins)	488

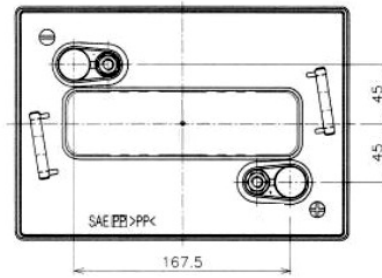

5-Hr Capacity By Temperature

40°C	105%
30°C	100%
0°C	80%

Dimensions

Length (mm)	259
Width (mm)	179
Height (mm)	245
Height over terminals (mm)	276
Mass (kg)	30.7

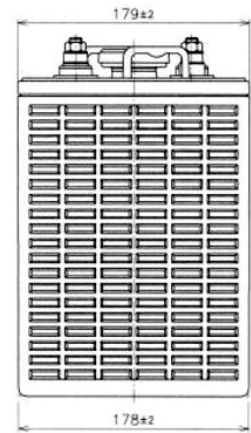
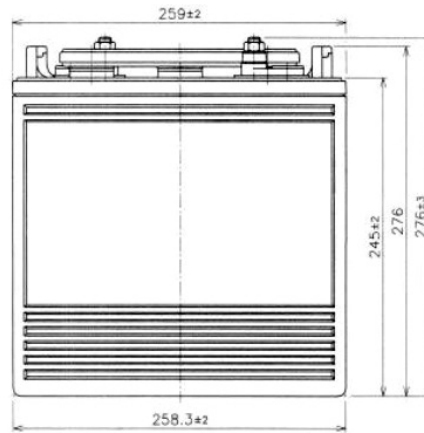

Material Specifications

Cover Style	: Removable - Maintenance Possible
Cover Vent Style	: Gang style
Container & Cover Material	: Black polypropylene plastic
Case to Cover Seal Method	: Heat sealing
Inner Cell Connector Type	: Through-partition weld
Plate Lug Weld Method	: Automated cast-on process
Positive Grid Material	: Antimony lead alloy
Negative Grid Material	: Antimony lead alloy

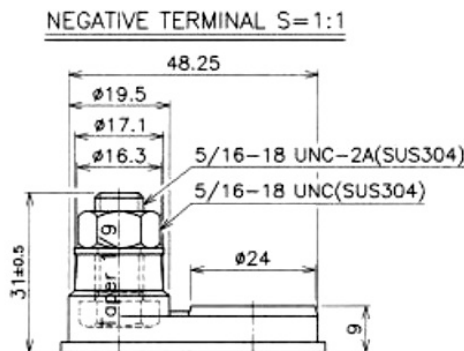
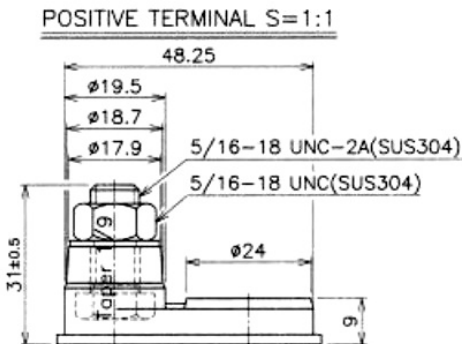

Data Sheet generated on 16/12/2020 - E&OE