

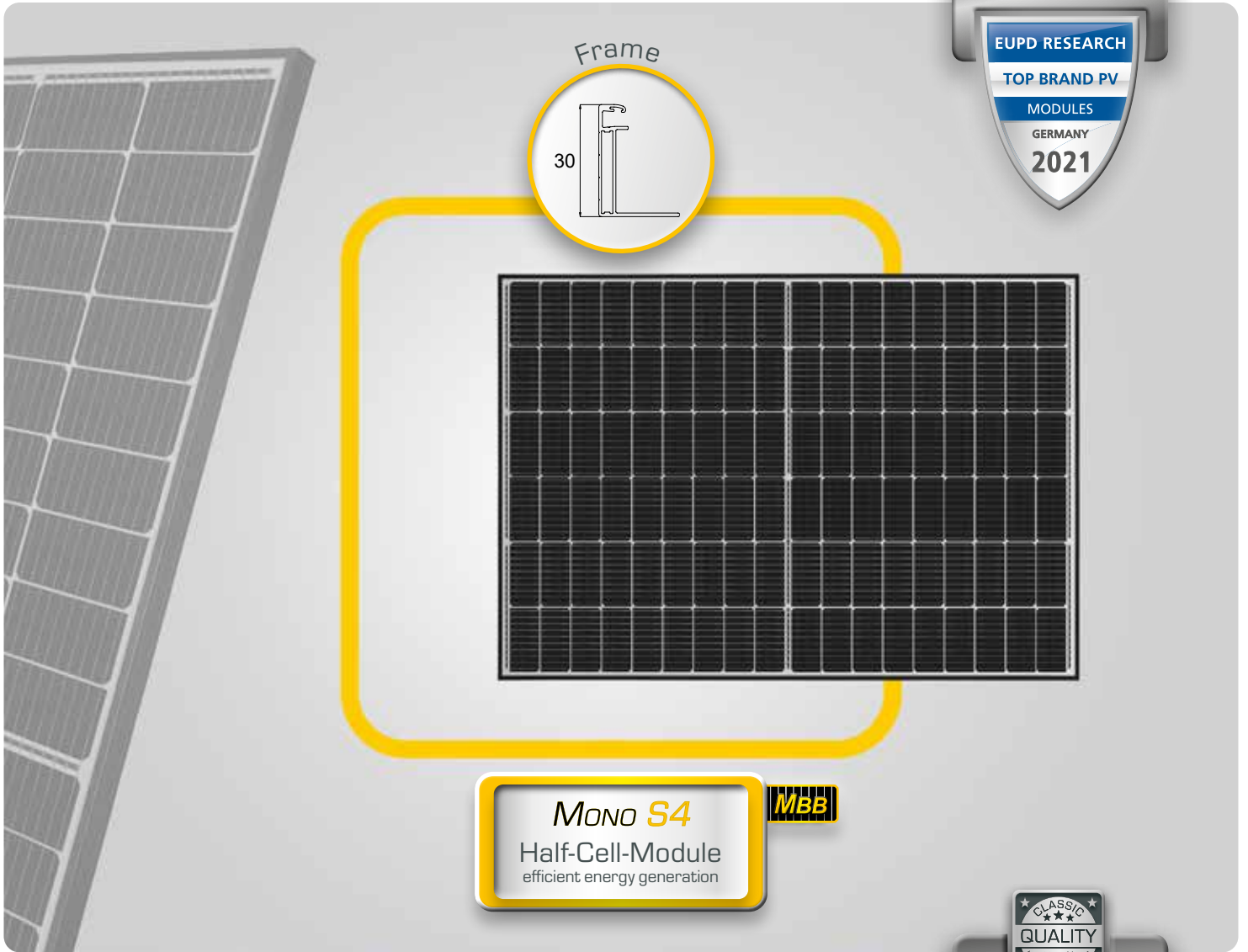

Solar Modules MONOCRYSTALLINE



Mono S4 - Halfcut

405 W • 410 W

- Half cell modules - High efficiency, high safety, high reliability
- Highly transparent self-cleaning glass
- High performance under low light conditions
- Resistant to environmental influences: Passed salt mist & ammonia test
- Multibusbar-technology
- Area utilization 209.72 W/m² at 410 W
- German warranty

Mono S4 - Halfcut

Electrical data under STC (Standard Test Conditions: 1000 W/m², 25 °C, AM 1.5)

Rated power	P_{max}	405 W	410 W
Sorting limits of performance		0/+3 %	0/+3 %
Voltage	U_{MPP}	31,52 V	31,76 V
Open circuit voltage	U_{OC}	37,42 V	37,66 V
Current	I_{MPP}	12,85 A	12,91 A
Short-circuit current	I_{SC}	13,60 A	13,66 A
Efficiency		20,71 %	20,96 %

Temperature data

Operating temperature		- 40° C ~ + 85° C
Nominal operating cell temperature		45 ± 2° C
Power temperature coefficient	$T_k (P_{MPP})$	-0.36 %/K
Voltage temperature coefficient	$T_k (U_{OC})$	-0.28 %/K
Current temperature coefficient	$T_k (I_{SC})$	0.05 %/K

Further information

Number of cells	108 monocrystalline half cells (6 x 18)	
Size of cell	182 x 91 mm	
Module dimensions	1724 x 1134 x 30 mm	
Type of Frame	Anodized aluminium alloy	
Max. system voltage	1500 V	
Reverse current loading capability	25 A	
Glass thickness	3.2 mm	
Weight	21.5 kg	
Module connection	MC4 compatible, 4.0 mm ² , cable length: (+) ≥ 1200 mm, (-) ≥ 1200 mm	
Junction box rating	IP68	
Allowable Hail Load	25 mm iceball with velocity of 23 m/s	
Snow load	5400 Pa $\hat{=}$ 550 kg/m ²	

15-year product warranty, 25-year linear performance warranty according to our additional warranty conditions for solar power modules of the "Mono S4" product series, which we will gladly send you.

Due to the tolerance of the anti-reflective coating, colour differences in the All Black modules may occur.

Subject to technical modifications with corresponding follow-up certifications. Errors excepted. Illustration similar.

Mono S4 - Halfcut (half cell module)

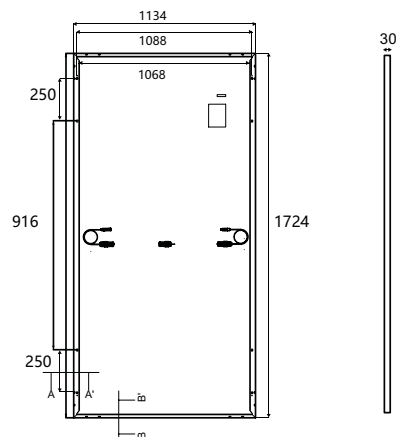

Note:
Ensure correct polarity!

Valid as of: 11.02.2022 / Document No.: 0920-M9-3-4-53-E

Packaging Specifications

Truck	
Dimension pallet (L/W/H)	176/114/127.5 cm
Weight pallet	approx. 785 kg
Modules per pallet	36
Modules per truck	936

Shipment	
Dimension pallet (L/W/H)	176/114/127.5 cm
Weight pallet	approx. 785 kg
Modules per pallet	36
Modules per container [40' HC]	864

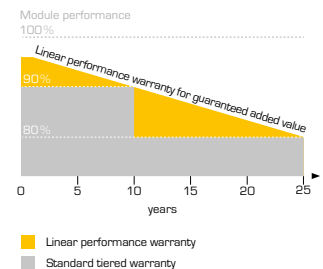
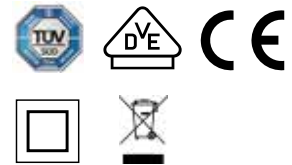

Your specialist dealer:

Solar Fabrik GmbH
Hermann-Niggemann-Str. 7
63846 Laufach
Deutschland

Telefon: +49 (0)6093 20770-0
Telefax: +49 (0)6093 20770-99
E-Mail: info@solar-fabrik.de
Internet: www.solar-fabrik.de