

Tiger Neo N-type 54HL4-(V) 410-430 Watt MONO-FACIAL MODULE

N-Type

Positive power tolerance of 0~+3%

IEC61215(2016), IEC61730(2016)

ISO9001:2015: Quality Management System

ISO14001:2015: Environment Management System

ISO45001:2018

Occupational health and safety management systems

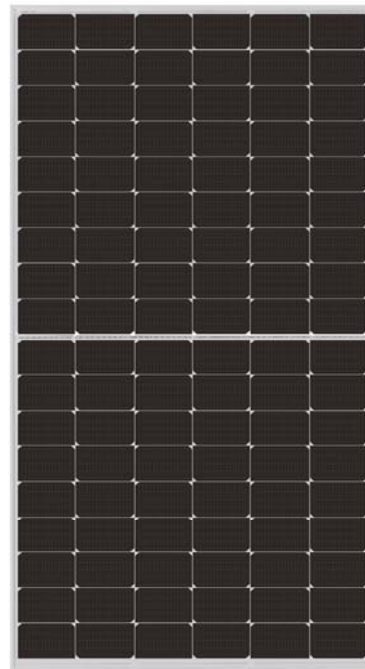

Key Features



SMBB Technology

Better light trapping and current collection to improve module power output and reliability.



PID Resistance

Excellent Anti-PID performance guarantee via optimized mass-production process and materials control.



Durability Against Extreme Environmental Conditions

High salt mist and ammonia resistance.



Hot 2.0 Technology

The N-type module with Hot 2.0 technology has better reliability and lower LID/LETID.



Enhanced Mechanical Load

Certified to withstand: wind load (2400 Pascal) and snow load (5400 Pascal).



LINEAR PERFORMANCE WARRANTY

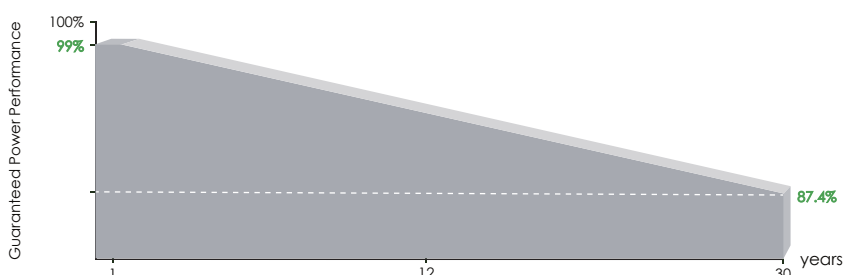

15 Year Product Warranty

30 Year Linear Power Warranty

0.40% Annual Degradation Over 30 years

Engineering Drawings

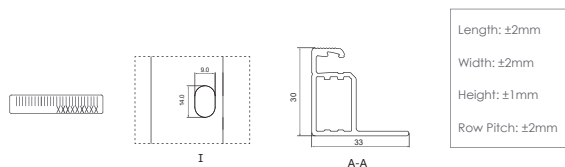
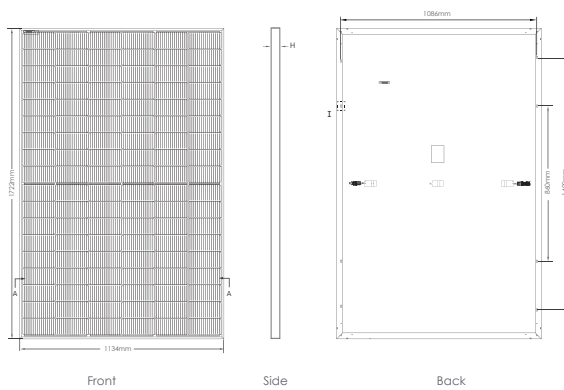

Packaging Configuration

(Two pallets = One stack)

36pcs/pallets, 72pcs/stack, 936pcs/ 40'HQ Container

Electrical Performance & Temperature Dependence

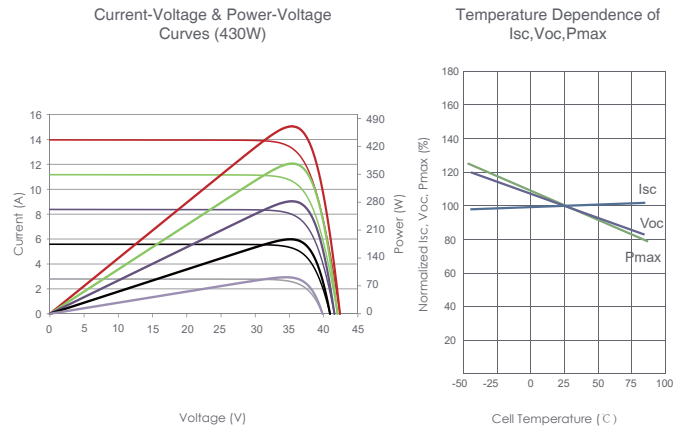

Mechanical Characteristics

Cell Type	N type Mono-crystalline
No. of cells	108 (6×18)
Dimensions	1722×1134×30mm (67.79×44.65×1.18 inch)
Weight	22 kg (48.50 lbs)
Front Glass	3.2mm, Anti-Reflection Coating, High Transmission, Low Iron, Tempered Glass
Frame	Anodized Aluminium Alloy
Junction Box	IP68 Rated
Output Cables	TUV 1×4.0mm ² (+): 400mm, (-): 200mm or Customized Length

SPECIFICATIONS

Module Type	JKM410N-54HL4		JKM415N-54HL4		JKM420N-54HL4		JKM425N-54HL4		JKM430N-54HL4	
	STC	NOCT	STC	NOCT	STC	NOCT	STC	NOCT	STC	NOCT
Maximum Power (Pmax)	410Wp	308Wp	415Wp	312Wp	420Wp	316Wp	425Wp	320Wp	430Wp	323Wp
Maximum Power Voltage (Vmp)	31.13V	29.06V	31.32V	29.21V	31.51V	29.34V	31.70V	29.50V	31.88V	29.63V
Maximum Power Current (Imp)	13.17A	10.61A	13.25A	10.68A	13.33A	10.76A	13.41A	10.83A	13.49A	10.91A
Open-circuit Voltage (Voc)	37.73V	35.84V	37.92V	36.02V	38.11V	36.20V	38.30V	36.38V	38.49V	36.56V
Short-circuit Current (Isc)	13.91A	11.23A	13.99A	11.29A	14.07A	11.36A	14.15A	11.42A	14.23A	11.49A
Module Efficiency STC (%)	21.00%		21.25%		21.51%		21.76%		22.02%	
Operating Temperature(°C)	-40°C~+85°C									
Maximum system voltage	1000/1500VDC (IEC)									
Maximum series fuse rating	25A									
Power tolerance	0~+3%									
Temperature coefficients of Pmax	-0.29%/°C									
Temperature coefficients of Voc	-0.25%/°C									
Temperature coefficients of Isc	0.045%/°C									
Nominal operating cell temperature (NOCT)	45±2°C									

*STC: Irradiance 1000W/m² Cell Temperature 25°C AM=1.5
 NOCT: Irradiance 800W/m² Ambient Temperature 20°C AM=1.5 Wind Speed 1m/s



TS4-A-O

Ottimizzatore FV a livello di modulo

TS4-A-O (Ottimizzazione) è la soluzione avanzata add-on che aggiunge caratteristiche Smart ai moduli FV tradizionali per ottenere la massima affidabilità, migliorando il rendimento di impianti sottoperformanti o rendendo Smart le nuove installazioni.

TS4-A-O supporta moduli FV di potenza fino a 700Wp.

Funzionalità incluse



Ottimizzazione per il miglior rendimento energetico e la massima flessibilità di progettazione



Spegnimento automatico o manuale



Monitoraggio a livello di modulo per il rilevamento della produzione e per la gestione del parco impianti

Facilità di Installazione

Fissabile alla cornice del modulo o al sistema di montaggio

Smart Commissioning

Configurazione e messa in funzione realizzabili da dispositivo Android/iOS



TS4-A-O DATI TECNICI

Specifiche Ambientali

Intervallo della Temperatura Operativa -40°C to +70°C (-40°F to +158°F)

Classe di Protezione IP68

Altitudine Massima 2000m

Specifiche Meccaniche

Dimensioni W=138.4mm, L= 139.7mm, H= 22.9mm

Peso 520g

Specifiche Elettriche

Massima Tensione in Ingresso (V_{OC} alla temperatura più bassa) 80V

Intervallo di Tensione 16 - 80V

Corrente Massima 15A

Potenza Massima 700W

Lunghezza Cavo di Uscita 1.2m (standard)

Connettori MC4, EVO2

Tipo di Comunicazione Wireless

Potenza Fusibile Raccomandata 30A

CCA e TAP necessari per funzioni di monitoraggio e sicurezza con TS4-A-O.

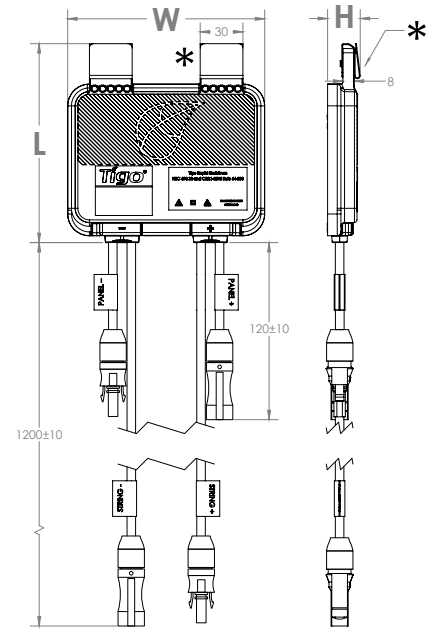

*Clip rimovibili per montaggio su struttura

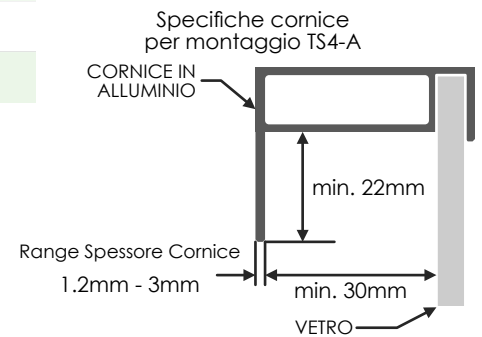

NOTA PER L'ORDINE

Part Number	Descrizione
461-00252-32	1000V TÜV, 1.2m cable, MC4
461-00261-32	1500V TÜV, 1.2m cable, EVO2

Per informazioni commerciali:

sales@tigoenergy.com

Per informazioni sui prodotti:

tigoenergy.com/products

Per informazioni tecniche:

support.tigoenergy.com

Per informazioni aggiuntive e assistenza alla selezione dei prodotti, si prega di utilizzare il configuratore online all'indirizzo

tigoenergy.com/design

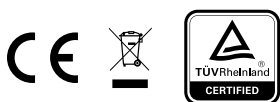

Tigo[®]

PV 2.0